

PRODUCT DATASHEET

FL FLEX DA P 130W 840 R30 WAL

FLOODLIGHT FLEX DALI RADIAL SYMMETRIC 30 | DALI D4i floodlight with radial symmetric light distribution for high mast area lighting



Areas of application

- Coastal areas, like ports
- General outdoor area lighting
- Parking
- Suitable for indoor and outdoor sports facilities
- Architectural lighting
- Industry
- Direct replacement for luminaires using HID lamps

Product benefits

- Corrosion resistance C5: tested in environments with high salinity
- Serviceable luminaire: LED driver can be replaced
- Flexible application due to a range of different lumen packages and beam angles
- 3 cable entries for flexible use and easy connection between luminaires
- Integrated breather for preventing condensation inside the luminaire
- Energy savings of up to 91 % compared to halogen lamp floodlights
- Energy savings of up to 51 % compared to luminaires that use conventional discharge lamps
- No upper light output ratio (ULOR 0%) when mounted at 0° tilt
- Intelligent design of the water drain to prevent standing water
- Simple angle adjustment by locking every 2.5°
- Clear angular degree indication
- Key hole to ensure ease of installation

Product features



- Corrosion resistance C5 based on 1,500 hours salt mist spray test
- High luminous efficacy: up to 160 lm/W
- DALI D4i drivers for smart city applications
- Daisy chaining possible
- High surge protection: up to 10 kV (L/N-PE), 6 kV (L-N)
- High lifetime (L70/B50): up to 120,000 h (at 25 °C)
- Lumen packages up to 70000 lm
- Additional 2200 K color temperature version available

TECHNICAL DATA

Electrical data

Nominal wattage	130.00 W
Nominal voltage	220...240 V
Mains frequency	50...60 Hz
Nominal current	586.000 mA
Inrush current	125 A
Inrush current time T_{h50}	122 μ s
Max. number of luminaires per miniature circuit breaker B16	9
Max. number of luminaires per miniature circuit breaker C10	8
Max. number of luminaires per miniature circuit breaker C16	14
Power factor λ	> 0.90
Total harmonic distortion	< 20 %
Protection class	I
Surge capability (L-N)	6 kV
Surge capability (L/N-Ground)	10 kV
Operating mode	Integrated LED driver
Dimming interface	DALI-2 / IoT

Photometrical data

Luminous flux	20800 lm
Luminous efficacy	160 lm/W
Color temperature	4000 K
Light color (designation)	Cool White
Color rendering index Ra	> 80
Standard deviation of color matching	5 sdc _m
Low flicker	Yes
Flickering metric (Pst LM)	<1
Stroboscope effect metric (SVM)	<0.4
Photobiological safety group acc. to EN62778	RG1
Beam angle	30 °

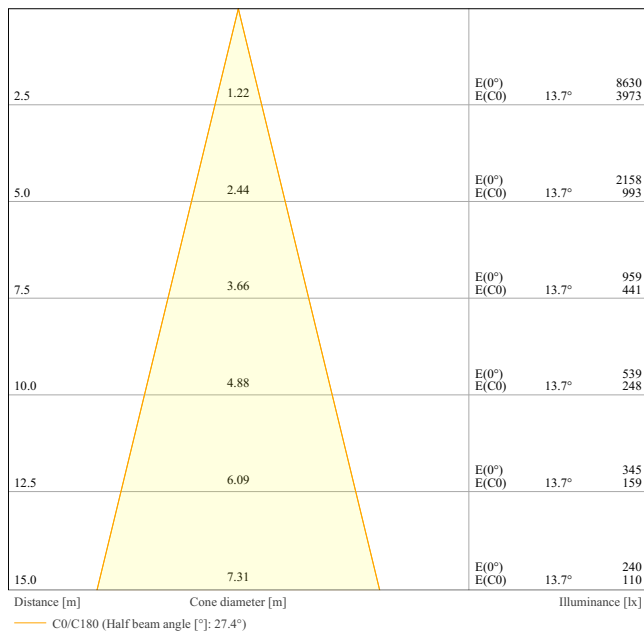

FL FLEX DA/P 130W ML 840 R30 WAL

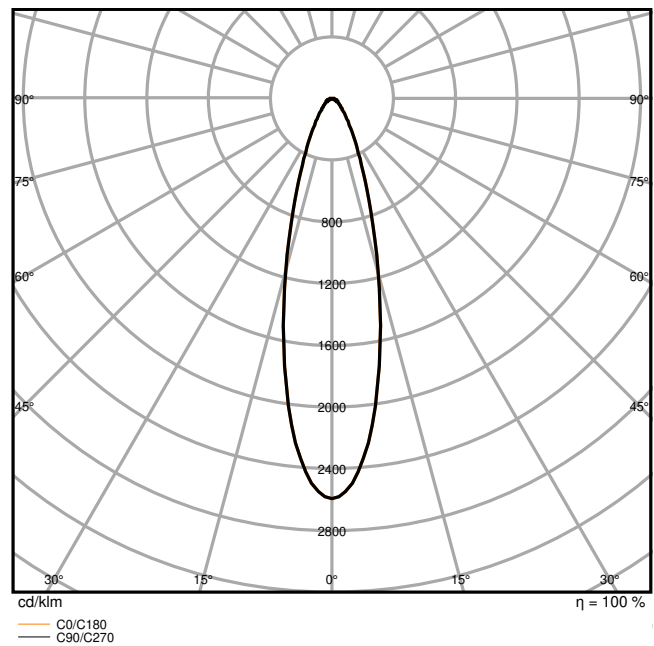

FL FLEX DA P 130W 840 R30 WAL LEDV

Dimensions & Weight

Length	492.00 mm
Width	361.00 mm
Height	68.00 mm
Product weight	6000.00 g

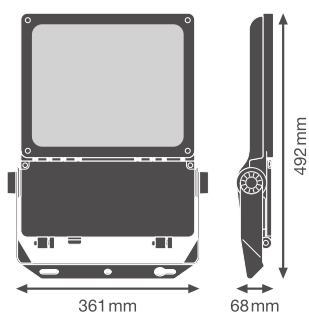

FL FLEX P WAL

Materials & Colors

Product color	White aluminum
Housing color	White aluminum
RAL Color (most similar)	RAL 9005
Body material	Aluminum
Cover material	Glass
Light emitting surface material	Glass
Glow Wire Test according to IEC 60695-2-12	850 °C
Mercury content	0.0 mg

Application & Mounting

Ambient temperature range	-30...+50 °C
Temperature range at storage	-30...+80 °C
Type of connection	Screwless terminal
Type of protection	IP66
Protection class IK (shock resistance)	IK08
Corrosion resistance class acc. to EN 12944	C5
Dimmable	Yes
Type of dimming	DALI D4i
IoT ready	Support of DALI data type PART 251, 252, 253 ¹⁾
Mounting type	Surface
Mounting location	Wall / Pole / Floor / Ceiling
Application environment	Outdoor
Adjustable	Yes
With light source	Yes
Replaceable light source	No

¹⁾ Internet of Things. Supports data transfer via gateway to cloud-based monitoring platforms, such as LEDVANCE VIVARES Cloud

Lifespan

Lifespan L70/B50 at 25 °C	120000 h ¹⁾
Lifespan L80/B10 at 25 °C	100000 h ¹⁾
Lifespan L80/B50 at 25 °C	100000 h
Lifespan L90/B10 at 25 °C	50000 h
Number of switching cycles	100000

¹⁾ t[h]: L70 / B50 @ 25 °C (Ta), t[h]: L80 / B10 @ 25 °C (Ta), t[h]: L90 / B10 @ 25 °C (Ta)

Control gear

Output current	4200 mA
ECG - Output ripple current	< 10 %



Certificates & Standards

Standards	CE / CB / ENEC / UKCA / EPD
Luminaire with limited surface temperature, "D sign"	Yes
EPD	LEDV-00046-V01.01-EN

Additional product data

Added function	VIVARES
----------------	---------



Accessories Optional







Product image	Product name	EAN
	FL TRAVERSE 1/2 42/60/76MM	4099854680038
	FL FLEX ADAPTER SOCKET ZHAGA	4099854680076
	FL FLEX ADAPTER SOCKET NEMA	4099854680113







EQUIPMENT / ACCESSORIES



- Delivery without cables
- Second cable gland included
- 2 rubber inserts for 6,5 - 7,5 mm cables included

DOWNLOAD DATA

Documents and certificates	Document name
 User instruction / safety instructions	FL FLEX P DALI
 Legal information	Informationstext 18 Abs 4 ElektroG

Documents and certificates		Document name
	Legal information	Safety Insert G11205497
	Legal information	LSI FL FLEX DALI
	Legal information	FL FLEX DA P
	Declarations of conformity	CE FL FLEX P
	Declarations of conformity UKCA	UKCA FL FLEX P
	Certificates	ENEC FL FLEX P
	EU Data Act	DALI LED Driver and Luminaires

Photometric and lighting design files		Document name
	IES file (IES)	FL FLEX DA P 130W 840 R30 WAL LEDV
	LDT file (Eulumdat)	FL FLEX DA P 130W 840 R30 WAL LEDV
	ULD file (DIALux)	FL FLEX DA P 130W 840 R30 WAL
	ROLF file (RELUX)	FL FLEX DA P 130W 840 R30 WAL
	Light distribution curve type cone	FL FLEX DA/P 130W ML 840 R30 WAL
	Light distribution curve type polar	FL FLEX DA P 130W 840 R30 WAL LEDV

CAD/BIM files		Document name
	BIM Revit 3D	Floodlight Flex
	CAD STEP 3D	FL FLEX 130W

Tender texts		Document name
	Tender documents	FLOODLIGHT FLEX DALI RADIAL SYMMETRIC 30 130W 840 R30 WAL-en

LOGISTICAL DATA

Product code	Packaging unit (Pieces/Unit)	Dimensions (length x width x height)	Gross weight	Volume
4099854373459	Shipping box 1	572 mm x 402 mm x 119 mm	7303.00 g	27.36 dm ³

The mentioned product code describes the smallest quantity unit which can be ordered. One shipping unit can contain one or more single products. When placing an order, for the quantity please enter single or multiples of a shipping unit.

References / Links

– For Guarantee see www.ledvance.com/guarantee

DISCLAIMER

Subject to change without notice. Errors and omission excepted. Always make sure to use the most recent release.